



**avasco
solar**



datasheet

SolarSpeed 3.0 south landscape



SolarSpeed advantages

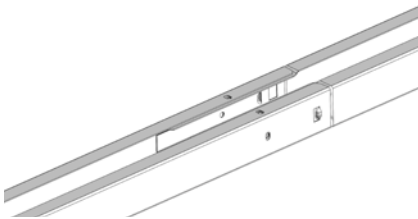

✓ click system

Basic units can be connected by a click system, which ensures good alignment and quick installation.

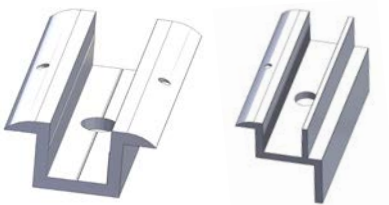

✓ clamps

The clamps are fastened onto the top profiles with M8 bolts for a reliable connection of your module.



✓ semi-assembled triangles

Working with semi-assembled triangles not only saves on installation time, but also drastically reduces the number of individual parts on the roof!



✓ made of zinc-magnesium steel





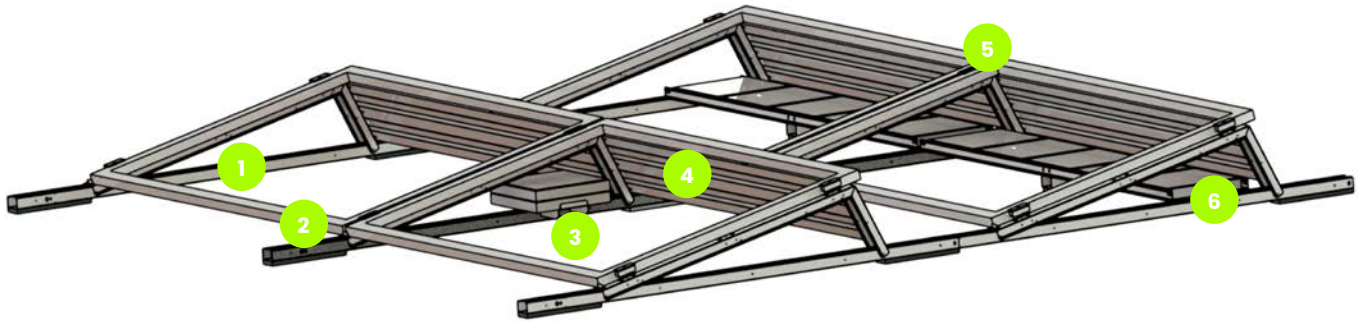

Perfect for applications with long-term corrosion resistance requirements. Self-healing properties and good electrical conductivity.



SolarSpeed components



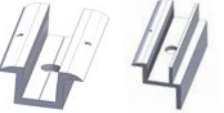





standard components

- 
1 basic unit:
semi-assembled triangle
+ rail + protective
rubbers*
- 
2 end rubber*
- 
3 ballast support
- 
4 backplate
- 
5 clamps + M8 bolts
- 
6 set of L-profiles
+ centre piece

* For PVC roofs use rubber with aluminium underlay.

additional components

- 
 concrete footing (12kg)
+ hammer plug
- 
 PP footing
- 
 C-rail end
reinforcement
- 
 omega bracket
- 
 ridge connection
- 
 anchor profile



SolarSpeed on concrete footing

- Easy to assemble by means of hammer plugs.
- Concrete footing also serves as ballast.
- Very good drainage due to increased space under the profiles.
- Ideal for pebbled and green roofs. Far fewer pebbles have to be removed compared to traditional frames.



SolarSpeed ballast supply

with sets of L-profiles

- The sets of L-profiles are used to place ballast under the modules and also serve as extra reinforcement of the frame.
- The support in the middle serves to prevent sagging of the L-profiles. These are secured with sheet metal screws.
- The extra connection between the basic units makes the installation even stronger.

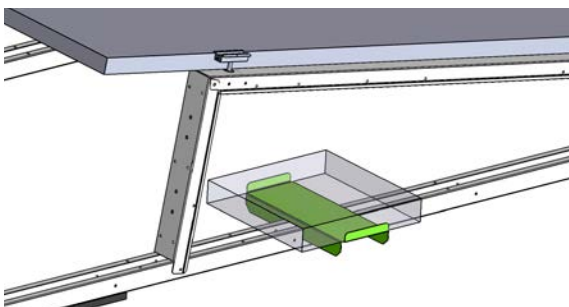

with ballast supports

- Ballast supports can be placed on the inside and outside of the installation.
- The ballast support can be quickly and easily slid over the rail of the basic unit.



ballast with online tool

online calculator

- With our free online software, you can work out your projects very quickly and easily!
- Define the location and environment, make a sketch of the roof, choose the modules and the mounting frame and after drawing up the PV installation, our software calculates the correct ballast plan.
- All information regarding roof loads, mounting structure and placement are included in a clear report, as well as a complete bill of materials.

tested and approved

- When developing our mounting frames, the most recent applicable standards and guidelines are always taken into account.
- These frames have undergone wind tunnel testing and the results have been incorporated into our calculations. In this way, we can present a complete technical file when elaborating your project.

dimensions and angles

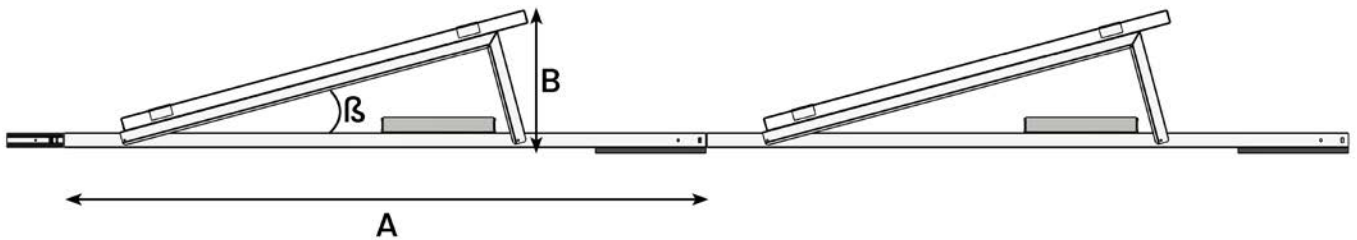

Panel Width	Pitch (A)	Height (B)
950 - 1310 MM · $\beta = 10,0^\circ$	1500 MM	250 - 275 MM
950 - 1310 MM · $\beta = 12,5^\circ$	1600 MM	285 - 320 MM
950 - 1310 MM · $\beta = 15,0^\circ$	1750 MM	325 - 365 MM

Other pitches are available on request.



**avasco
solar**



100% made in Belgium

SolarSpeed is manufactured from A to Z at our production site in Ypres. As a result, we are always in control of the quality of our products, throughout the entire production process. This local production under our own management also ensures that we can respond to market demands in an extremely flexible way. The standards that are applied at all times are those of our quality management system, ISO 9001.



on-site delivery

We always have a large number of mounting frames in stock in our warehouse. This allows us to continue to guarantee short delivery times, especially for your industrial projects. We deliver the materials directly to the site in Europe (intercontinental on demand).



Avasco Solar plc
Rodenbachstraat 53
8908 Vlamertinge - Belgium
T +32 (0)57 27 15 00
VAT BE 0721.474.320
info@avasco-solar.be
www.avasco-solar.be

**solar
mounting
frames**